

ASSEMBLY INSTRUCTION

MODEL : SC 258830 -2

DESCRIPTION : 2 DOOR SHOE CABINET

HARDWARE

A A1 MINIFIX (HOUSING) 4 set	A2 MINIFIX (EURO 24) 4 set	A3 MINIFIX CAP	A5 ALLEN KEY 1	B WOOD DOWEL 8 X 25 8	C CB SCREW M4X45MM 4	D CB SCREW M3.5X16MM 32	E 2 PIN STOPPER 1	F SHELF SUPPORT 12	G NAIL 5/8 30	H HINGES 5/8 4	I i1 PVC SQ KNOB 2	i2 CB SCREW M4X25MM 2	L 120mm Round TAPPER PVC LEG 4
--	----------------------------------	-------------------	-----------------------------	------------------------------------	-----------------------------------	--------------------------------------	--------------------------------	---------------------------------	----------------------------	-----------------------------	------------------------------------	-----------------------------	---

PART LIST

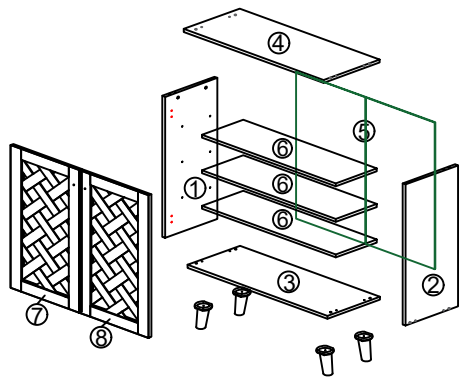

STEP 1

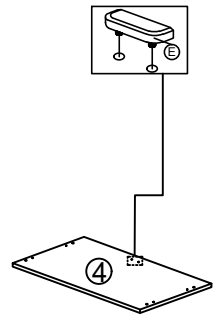

BOTTOM VIEW

STEP 2

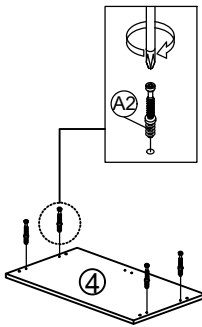

BOTTOM VIEW

STEP 3

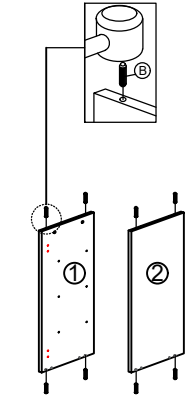

STEP 4

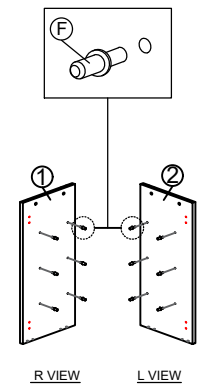

R VIEW

L VIEW

STEP 5

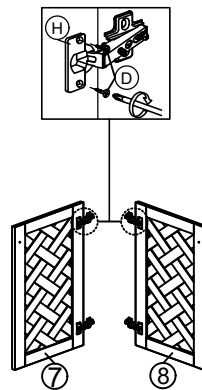

STEP 6

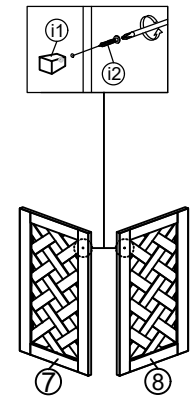

STEP 7

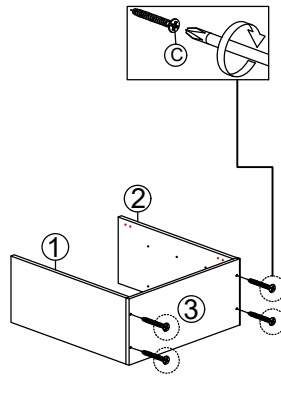

BOTTOM VIEW

STEP 8

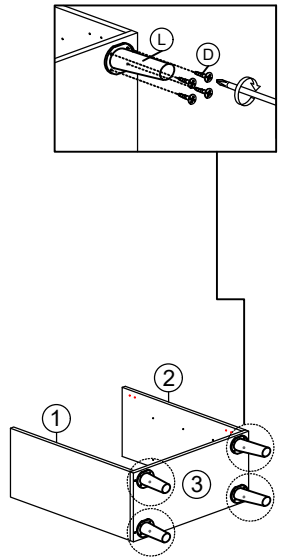

BOTTOM VIEW

STEP 9

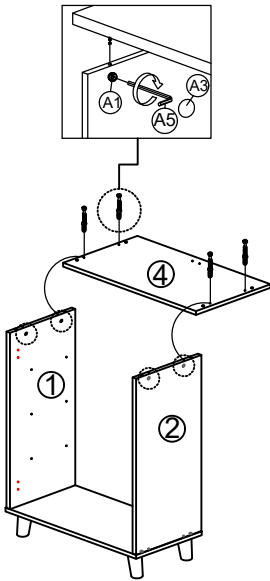

STEP 10

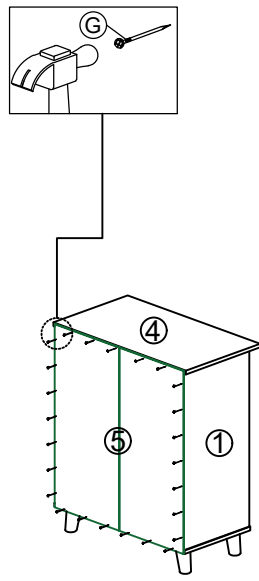

REAR VIEW

STEP 11

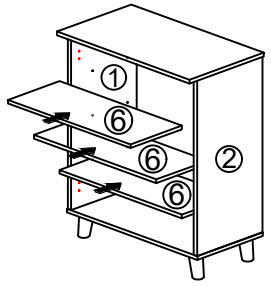

STEP 12

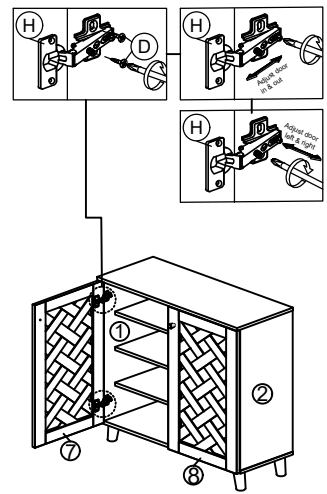

COMPLETED

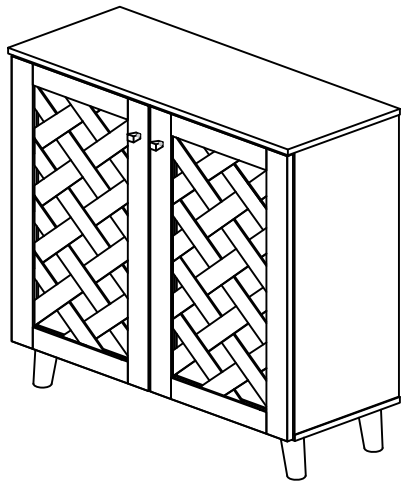

Installation of Anti-Tip Restraint

Kit includes:

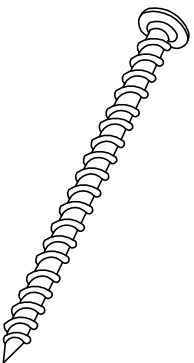

A (x1)
Long screw

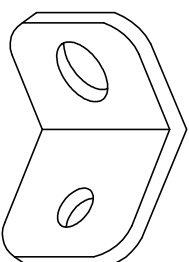

B (x2)
Mounting bracket

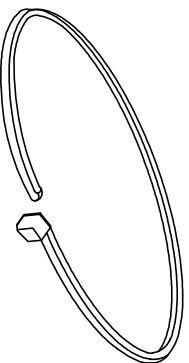

C (x1)
Restraint strap

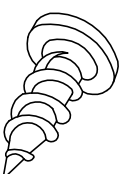

D (x1)
Short screw

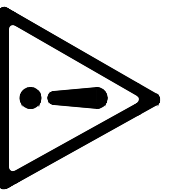

WARNING

Serious of fatal crushing injuries can occur from furniture tip-over. To help Prevent tip-over:

- Install tip-over restraint provided
- Place heaviest items in the lower drawers
- Do not set TV's or other heavy objects on top of this product
- Never allow children to climb or hang on drawers, doors or shelves
- Never open more than one drawer at a time
- Do not defeat or remove the drawer interlock system

Use tip-over restraints may only reduce but not eliminate the risk of tip-over.



IMPORTANT: Use of this safety kit is mandatory. This restraint is not a substitute for proper adult supervision. Failure to detach this restraint before moving furniture may result in injury and damage.

FITTING OF ANTI-TIP SAFETY STRAP

STEP 1:

- Attach the mounting bracket **(b)** to the furniture in the solid part below the top panel a few inches away from the side of the unit.
- Screw **(d)** through the smallest hole of **(b)**.

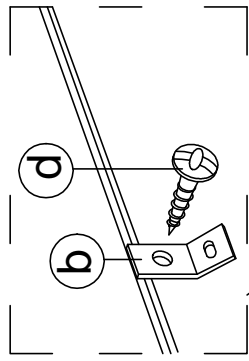

BACK SIDE OF TOP PANEL

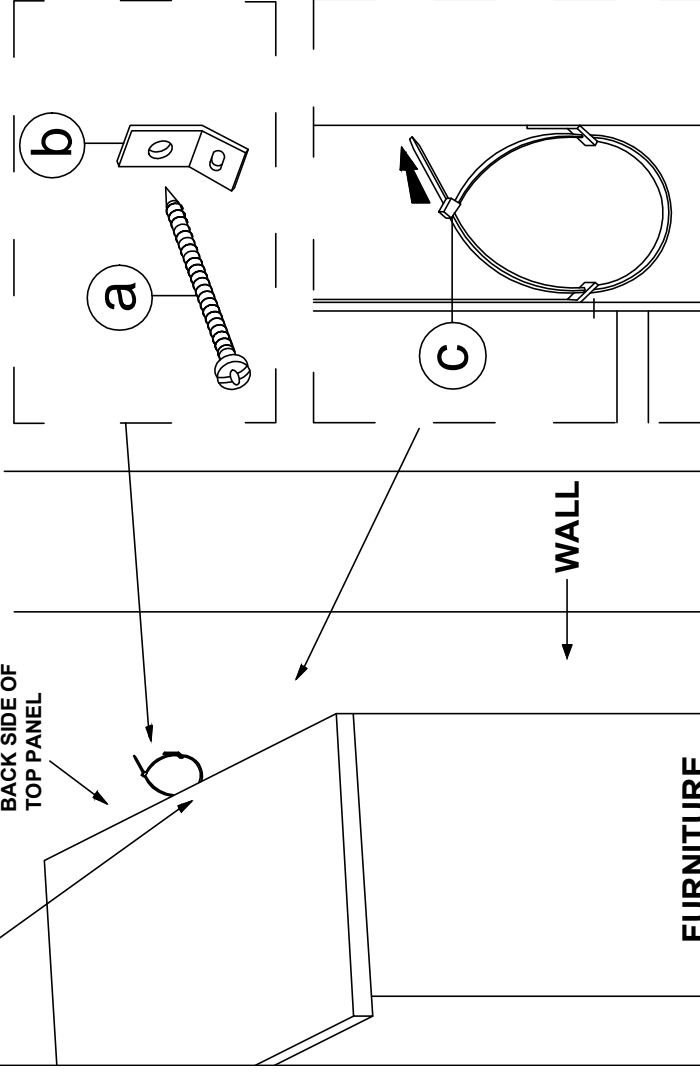

STEP 2:

- Locate a stud in behind the have to
- Place the other mounting bracket **(b)** on the wall stud 2 inches below the mounting bracket secured to the back of your unit.
- Attach to the wall stud using **(a)** through the smaller hole of **(b)**.

STEP 3:

- Repeat the same step a few inches away from the other side of the unit.
- Place the furniture into position so both mounting brackets are vertically in line.
- Lace the end of the restraint strap through the larger holes in each mounting bracket.
- Secure the straps and lock into place.

