

ASSEMBLY INSTRUCTION

MODEL : SC 25320-2

DESC : 2 DOOR SHOE CABINET

HARDWARE

A A1 MINIFIX (HOUSING) 8 SETS	A2 MINIFIX (EURO 24)	A3 MINIFIX CAP	A5 L KEY M4 1	B WOOD DOWEL M8 X 25MM 12	D CB SCREW M3.5X16MM 16	E CB SCREW M4X25MM 2	F SHELF SUPPORT 12	G NAIL 5/8 30	H HINGES 5/8 4	I 2 PIN STOPPER 1	J HANDLE KNOB-1625 2	K PVC NAIL WITH PIN 5/8 4
---	-------------------------	-------------------	----------------------------	--	--------------------------------------	-----------------------------------	---------------------------------	----------------------------	-----------------------------	--------------------------------	-----------------------------------	--

PART LIST

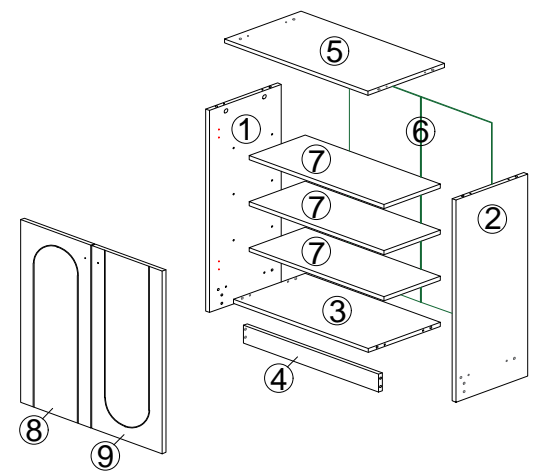

STEP 1

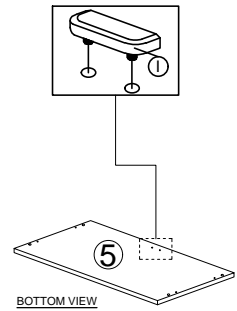

STEP 2

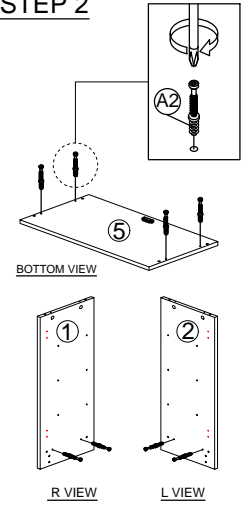

STEP 3

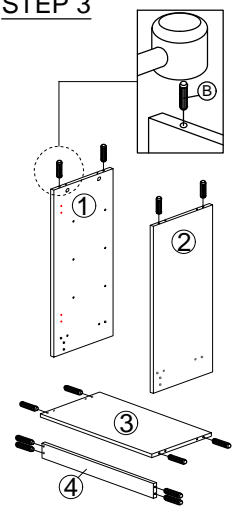

STEP 4

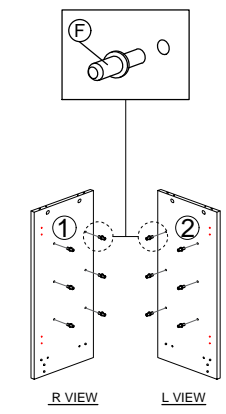

STEP 5

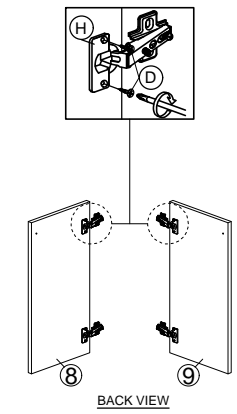

STEP 6

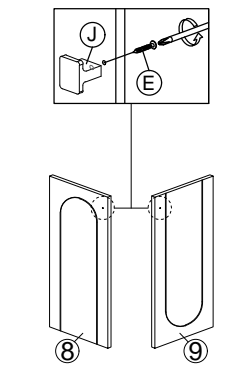

STEP 7

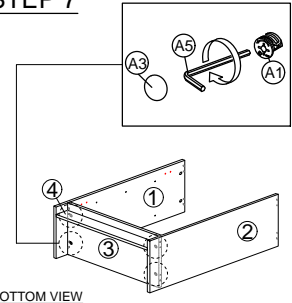

STEP 9

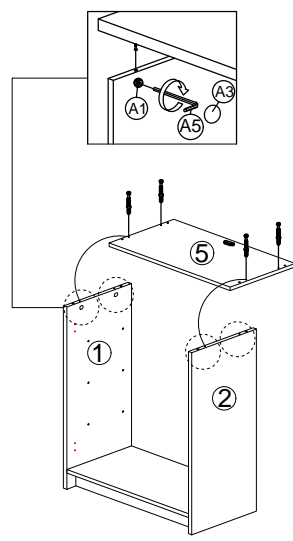

STEP 10

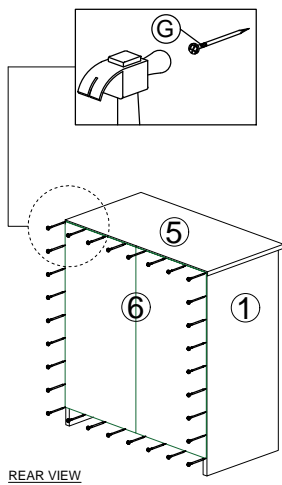

STEP 11

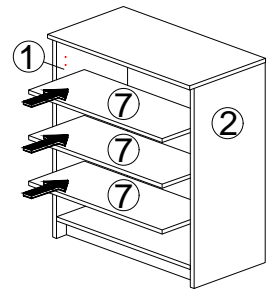

STEP 12

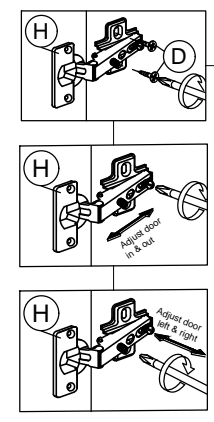

COMPLETED

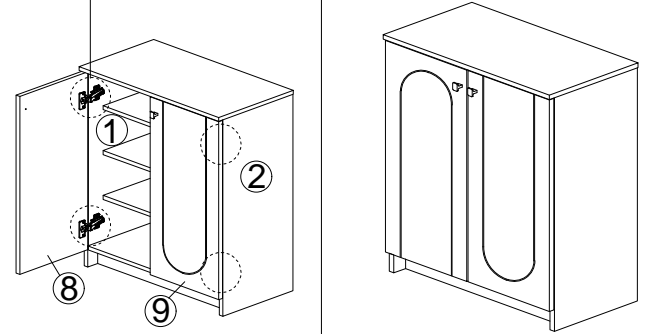

Installation of Anti-Tip Restraint

Kit includes:

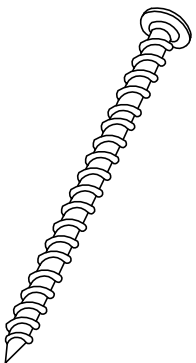

A (x1)
Long screw

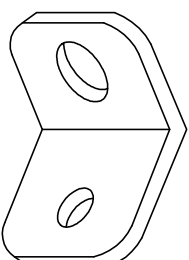

B (x2)
Mounting bracket

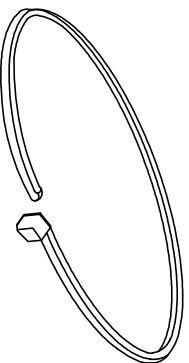

C (x1)
Restraint strap

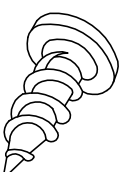

D (x1)
Short screw

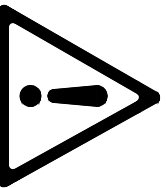

WARNING

Serious of fatal crushing injuries can occur from furniture tip-over. To help Prevent tip-over:

- Install tip-over restraint provided
- Place heaviest items in the lower drawers
- Do not set TV's or other heavy objects on top of this product
- Never allow children to climb or hang on drawers, doors or shelves
- Never open more than one drawer at a time
- Do not defeat or remove the drawer interlock system

Use tip-over restraints may only reduce but not eliminate the risk of tip-over.



IMPORTANT: Use of this safety kit is mandatory. This restraint is not a substitute for proper adult supervision. Failure to detach this restraint before moving furniture may result in injury and damage.

FITTING OF ANTI-TIP SAFETY STRAP

STEP 1:

- Attach the mounting bracket **(b)** to the furniture in the solid part below the top panel a few inches away from the side of the unit.
- Screw **(d)** through the smallest hole of **(b)**.

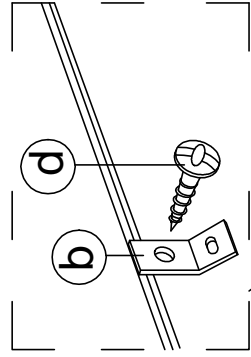

BACK SIDE OF TOP PANEL

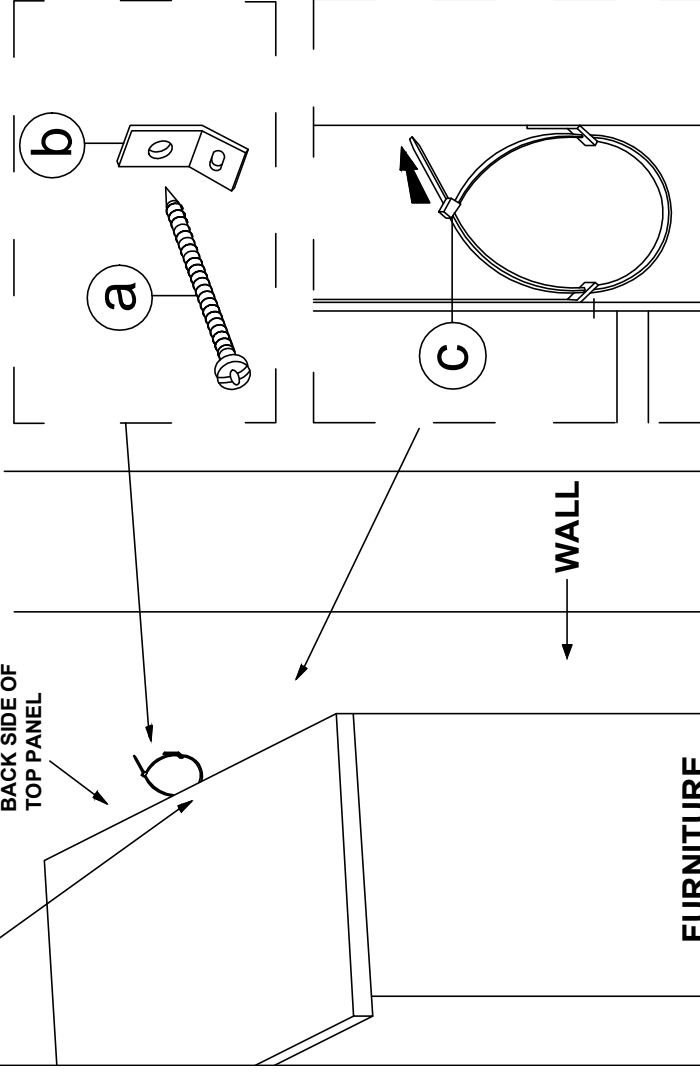

STEP 2:

- Locate a stud in behind the have to
- Place the other mounting bracket **(b)** on the wall stud 2 inches below the mounting bracket secured to the back of your unit.
- Attach to the wall stud using **(a)** through the smaller hole of **(b)**.

STEP 3:

- Repeat the same step a few inches away from the other side of the unit.
- Place the furniture into position so both mounting brackets are vertically in line.
- Lace the end of the restraint strap through the larger holes in each mounting bracket.
- Secure the straps and lock into place.

