

Your Ventilation answer.  
Integrated, clean, tidy and  
hidden away.

## Turbo Pack Plus

900MM, 1000M3H

BLACK

RT9B1000

- 3 Speed Settings
- 1000m3/hr Air Movement Capacity
- Removable Aluminium Mesh Filters
- LED Lights
- Push Button
- Noise 63db
- Ducting 150mm
- Remote Motoring Option
- 900mm x 296mm x 254mm
- 7 Year Warranty

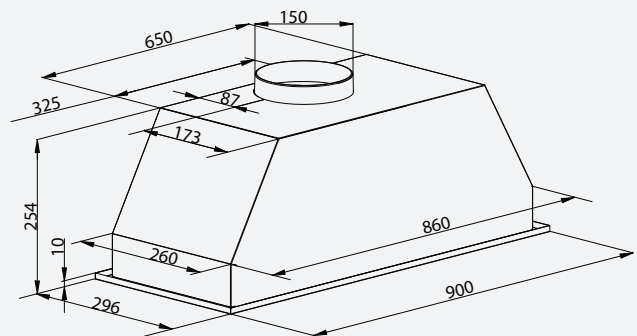

A smart clean, healthy solution for your home environment.

Rangehoods are an extra ventilation alternative suitable for built-in cabinets. Integrated Rangehoods like the Black Turbo Pak Plus 900mm are easily concealed by built-in cabinets easy to clean, and are the most cost-effective ventilation option.

Compatible with the Remote Motor Kit - RMKIT



Impressive 7 Year Warranty

Note: 7 year warranty is for domestic use only.  
For more information visit [www.parmco.co.nz](http://www.parmco.co.nz)

**PARMCO**

Inspiring kitchens, entertaining homes