

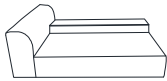







Assembly Instruction

A  x1	B  x1	C  x3	D  x1	E  x1	F  x4	G  x2	H  x4	I  x8	J  x1	K  x8	L  x2
--	---	---	---	---	--	---	---	---	---	---	---

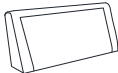

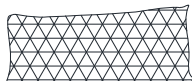
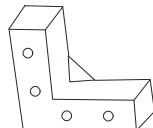
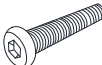
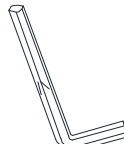
H
I
J
K

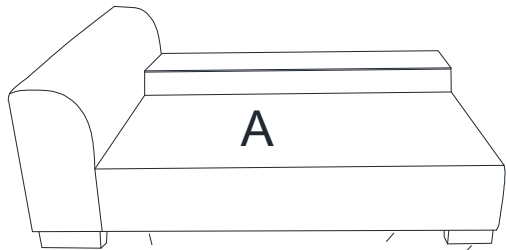
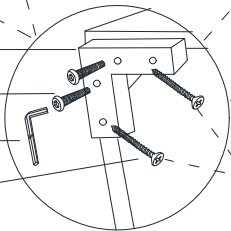

Assemble the sofa legs with a small hand.
Use according to personal needs.

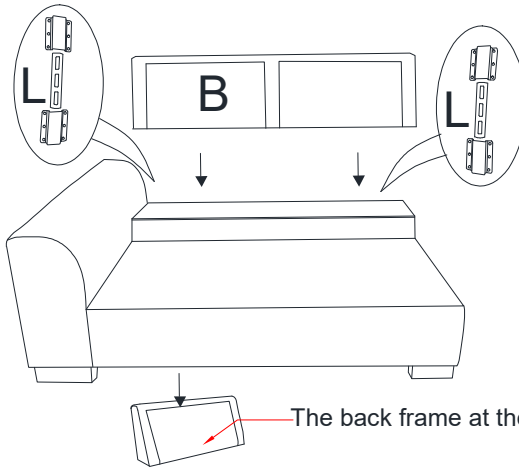

Assemble the back frame and seat frame together using plugs, as shown in the following figure.

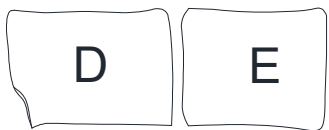
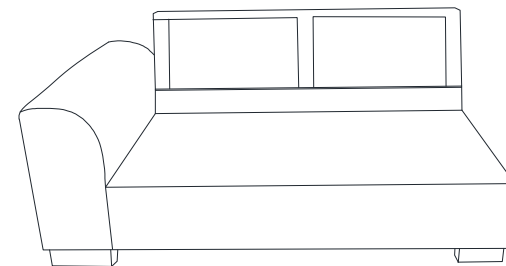







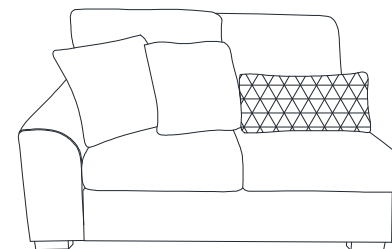
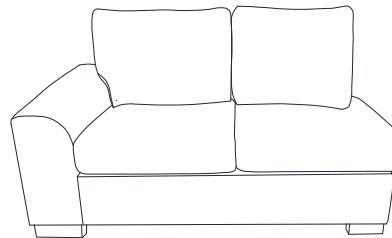
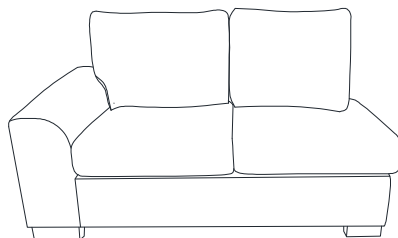
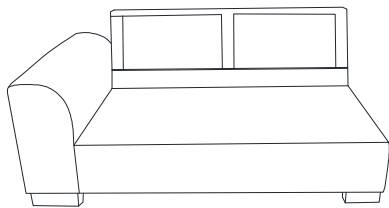

Arrange the seat cushion and backpack in sequence.

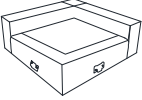

Simply place the small square bag and patterned strip bag.

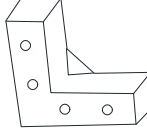
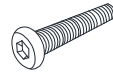
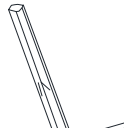

Assembly Instruction

A	B	C	D	E	F	G	H	I	J	K	L
											
x1	x1	x1	x1	x1	x1	x2	x4	x8	x1	x8	x4

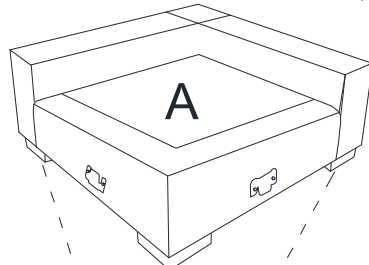

This back frame is under the armrest double seat frame!

This back rack is on the recliner seat rack!

Assemble the back frame and seat frame together using plugins, as shown in the following figure.

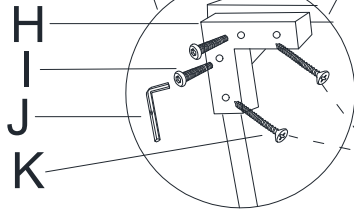
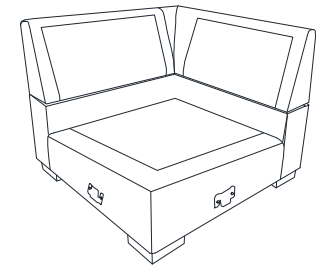
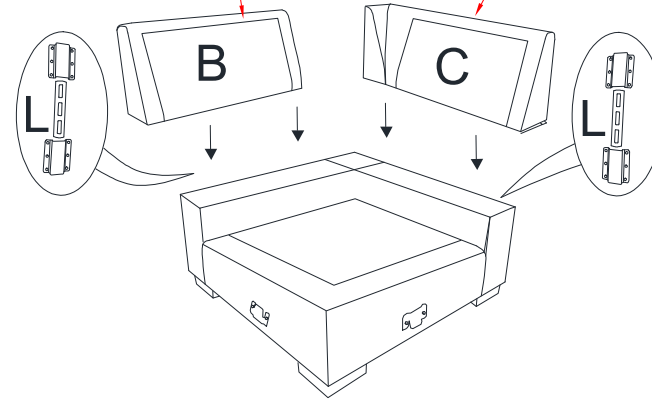

Assemble the sofa legs with a small hand. Use according to personal needs.

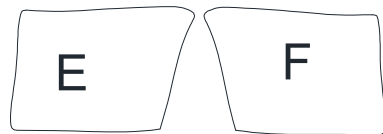

Arrange the seat cushion and backpack in sequence.



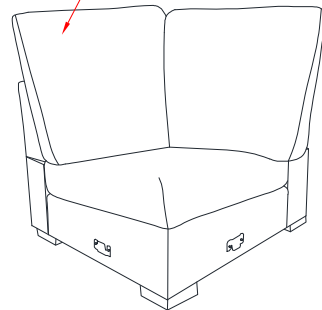
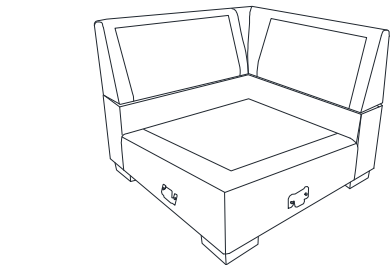

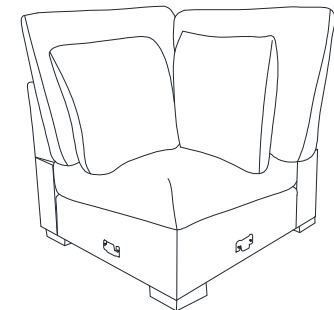
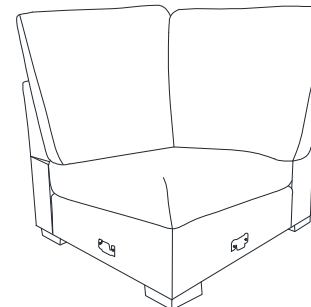

Two large backpacks are located under the frame of the lounge chair.

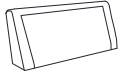

Simply place the small square bag and patterned strip bag.

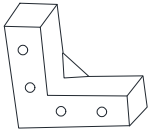
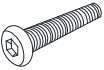
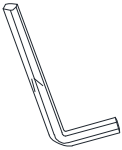

Assembly Instruction

A	B	C	D	E	H	I	J	K	L
									
x1	x1	x1	x2	x1	x4	x8	x1	x8	x4

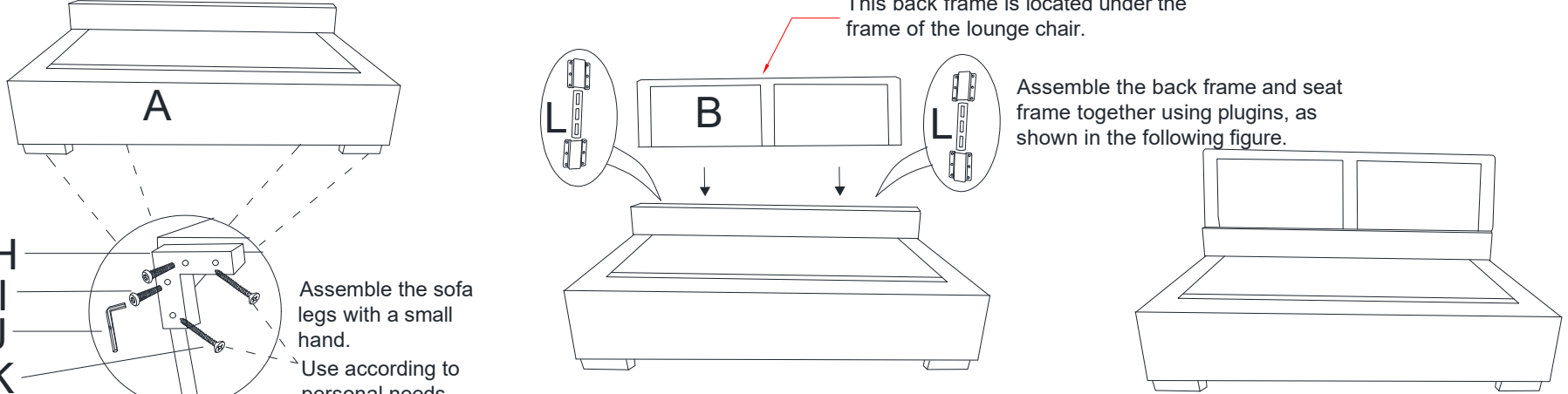

This back frame is located under the frame of the lounge chair.

Assemble the sofa legs with a small hand.
Use according to personal needs.

Assemble the back frame and seat frame together using plugins, as shown in the following figure.

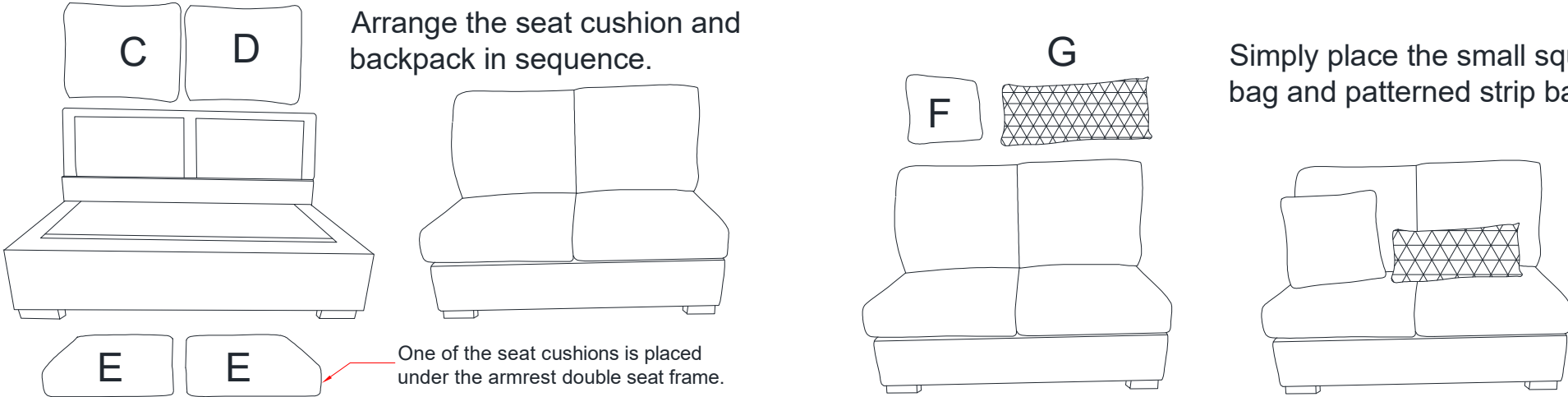





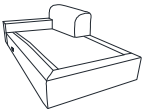
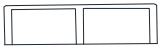

Arrange the seat cushion and backpack in sequence.

Simply place the small square bag and patterned strip bag.

One of the seat cushions is placed under the armrest double seat frame.

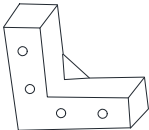
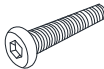
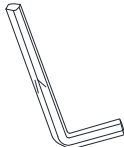
Assembly Instruction

A  x1	B  x1	C  x1	D  x3	E  x2	F  x4	G  x8	H  x1	I  x8	J  x2
--	--	--	--	--	--	--	--	--	--

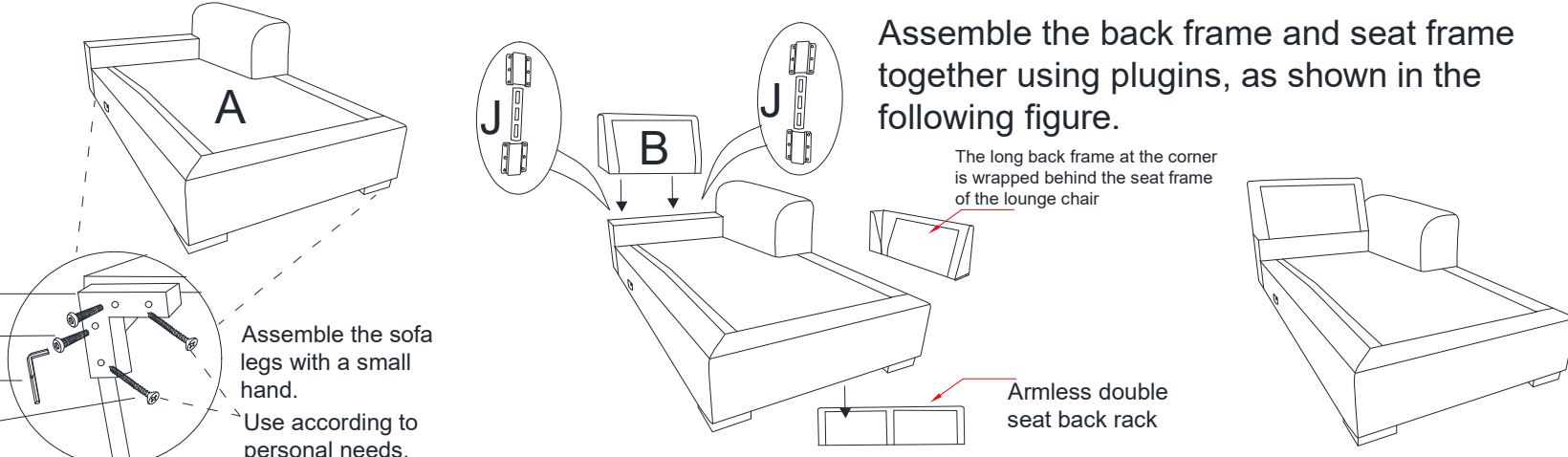

Assemble the back frame and seat frame together using plugs, as shown in the following figure.

The long back frame at the corner is wrapped behind the seat frame of the lounge chair

Assemble the sofa legs with a small hand.
Use according to personal needs.

Armless double seat back rack

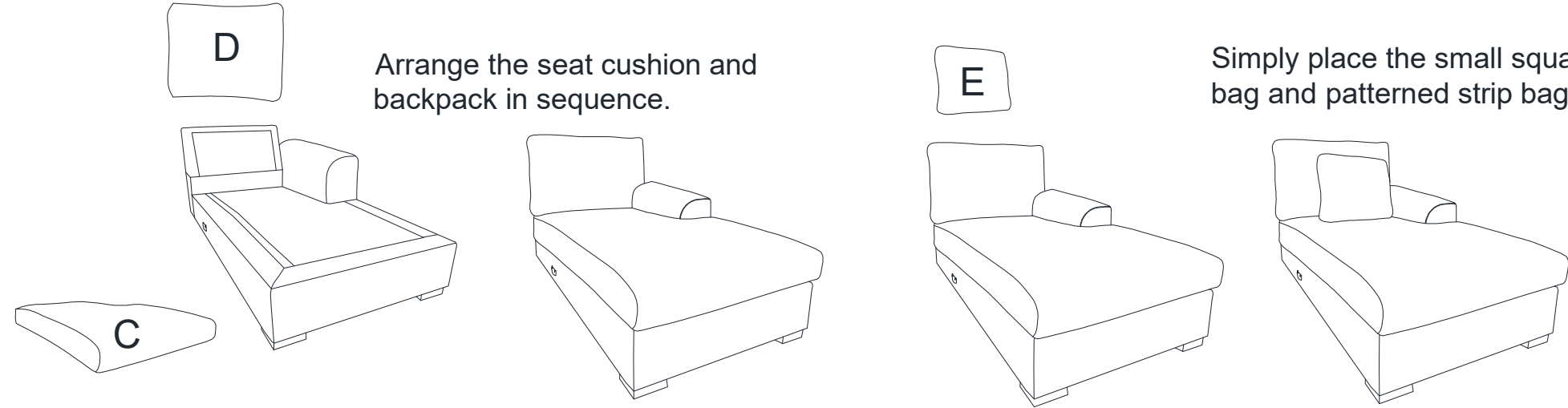

D Arrange the seat cushion and backpack in sequence.

E Simply place the small square bag and patterned strip bag.

